

MAXIM

Fault-Protected, High-Voltage, Signal-Line Protector

General Description

The MAX4505 is a single signal-line protector featuring a fault-protected input and Rail-to-Rail[®] signal handling capability. The input is protected from overvoltage faults up to $\pm 36\text{V}$ with power on or $\pm 40\text{V}$ with power off. During a fault condition, the input terminal becomes an open circuit and only nanoamperes of leakage current flow from the source, while the switch output (AOUT) furnishes typically 19mA from the appropriate polarity supply to the load. This ensures an unambiguous rail-to-rail output when a fault begins and ends.

The MAX4505 protects both unipolar and bipolar analog signals using either unipolar (+9V to +36V) or bipolar ($\pm 8\text{V}$ to $\pm 18\text{V}$) power supplies. The device has no logic control inputs; the protector is always on when the supplies are on. On-resistance is 100Ω max, and on-leakage is less than 0.5nA at $T_A = +25^\circ\text{C}$. The MAX4505 is available in 5-pin SOT23 and 8-pin μMAX packages.

Applications

Process Control Systems
Hot-Insertion Boards/Systems
Data-Acquisition Systems
Redundant/Backup Systems
ATE Equipment
Sensitive Instruments

Typical Operating Circuit

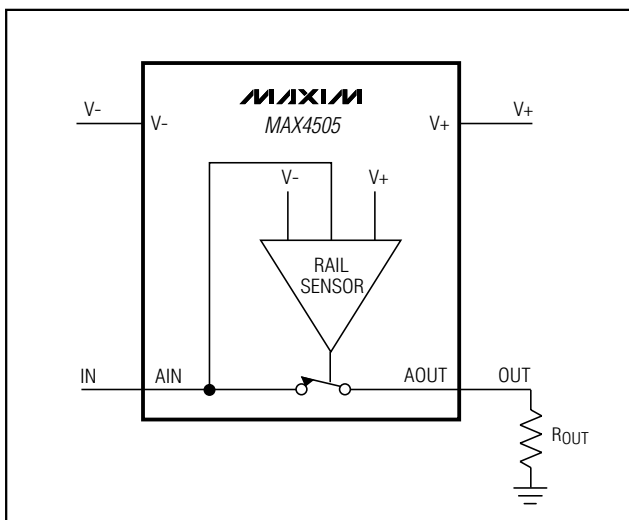

Rail-to-Rail is a registered trademark of Nippon Motorola, Ltd.

Features

- ◆ Overvoltage Protection
 $\pm 40\text{V}$ with Power Off
 $\pm 36\text{V}$ with Power On
- ◆ Open Signal Paths with Power Off
- ◆ Output Clamps to Either Rail with an Input Overvoltage
- ◆ 100Ω max On-Resistance
- ◆ 10ns Overvoltage Turn-On Delay
- ◆ No Latchup During Power Sequencing
- ◆ Rail-to-Rail Signal Handling
- ◆ 500Ω Output Clamp Resistance During Overvoltage
- ◆ Tiny 5-Pin SOT23 Package

Ordering Information

PART	TEMP. RANGE	PIN-PACKAGE	TOP MARK
MAX4505EUK-T	-40°C to +85°C	5 SOT23-5	ADLW
MAX4505EUA	-40°C to +85°C	8 μMAX	—

Pin Configurations

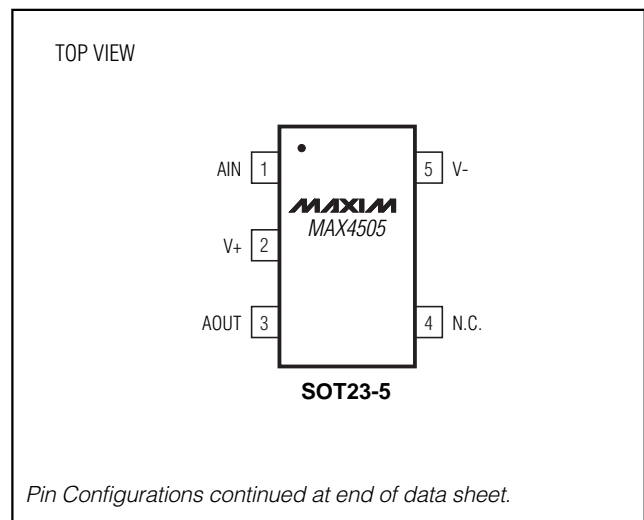
**MAXIM**

Maxim Integrated Products 1

For free samples & the latest literature: <http://www.maxim-ic.com>, or phone 1-800-998-8800.
For small orders, phone 1-800-835-8769.

MAX4505

Fault-Protected, High-Voltage, Signal-Line Protector

ABSOLUTE MAXIMUM RATINGS

(Voltages referenced to GND)

V+	-0.3V to +44.0V
V-	-44.0V to +0.3V
V+ to V-.....	-0.3V to +44.0V
AIN, AOUT (Notes 1, 2)	±44V
AIN Overvoltage with Power On	±36V
AIN Overvoltage with Power Off	±40V
Continuous Current into Any Terminal.....	±30mA
Peak Current into Any Terminal (pulsed at 1ms, 10% duty cycle).....	±70mA

Continuous Power Dissipation ($T_A = +70^\circ\text{C}$)

5-Pin SOT23-5 (derate 7.10mW/°C above +70°C) ...571mW

8-Pin μMAX (derate 4.10mW/°C above +70°C)330mW

Operating Temperature Ranges

MAX4505C _ _0°C to +70°C

MAX4505E_ _-40°C to +85°C

Storage Temperature Range-55°C to +150°C

Lead Temperature (soldering, 10sec)+300°C

Note 1: The AOUT pin is not fault protected. Signals on AOUT exceeding V+ or V- are clamped by internal diodes. Limit forward diode current to maximum current rating.

Note 2: The AIN pin is fault protected. Signals on AIN exceeding -36V to +36V may damage the device. These limits apply with power applied to V+ or V-, or ±40V with V+ = V- = 0.

Stresses beyond those listed under "Absolute Maximum Ratings" may cause permanent damage to the device. These are stress ratings only, and functional operation of the device at these or any other conditions beyond those indicated in the operational sections of the specifications is not implied. Exposure to absolute maximum rating conditions for extended periods may affect device reliability.

RECOMMENDED OPERATING GUIDELINES

V+ to GND	-0.3V to +40V
V- to GND	-32V to +0.3V
V+ to V-	±40V
AIN	±40V
AOUT.....	V+ to V-

AIN to AOUT.....40V differential

Continuous Current into Any Terminal≤30mA

Peak Current into Any Terminal

(pulsed at 1ms, 10% duty cycle)≤70mA

ELECTRICAL CHARACTERISTICS—Dual Supplies

(V+ = +15V, V- = -15V, $T_A = T_{\text{MIN}}$ to T_{MAX} , unless otherwise noted. Typical values are at $T_A = +25^\circ\text{C}$.) (Note 3)

PARAMETER	SYMBOL	CONDITIONS	T_A	MIN	TYP	MAX	UNITS	
ANALOG SWITCH								
Fault-Free Analog Signal Range (Note 4)	V_{AIN}	$V_{\text{AIN}} = \pm 15\text{V}$	E	V-		V+	V	
Analog Signal-Path Resistance	R_{ON}	$V_{\text{AIN}} = \pm 10\text{V}$, $I_{\text{AOUT}} = 1\text{mA}$	+25°C		65	100	Ω	
			E			125		
Signal-Path Leakage Current (Note 5)	$I_{\text{AOUT(ON)}}$	$V_{\text{AOUT}} = \pm 10\text{V}$, $V_{\text{AIN}} = \pm 10\text{V}$ or floating	+25°C	-0.5		0.5	nA	
			E	-20		20		
Input Capacitance	C_{AIN}	$V_{\text{AIN}} = 0$, $f = 1\text{MHz}$	+25°C		20		pF	
FAULT PROTECTION								
Fault-Protected Analog Signal Range (Notes 4, 6)	V_{AIN}	Applies with power on	E	-36		36	V	
			E	-40		40		
Input Signal-Path Leakage Current, Supplies On	$I_{\text{AIN(ON)}}$	$V_{\text{AIN}} = \pm 25\text{V}$, $V_{\text{AOUT}} = \text{open}$	+25°C	-20	0.1	20	nA	
			E	-200		200		
Input Signal-Path Leakage Current, Supplies Off	$I_{\text{AIN(OFF)}}$	$V_{\text{AIN}} = \pm 40\text{V}$, $V_{\text{AOUT}} = \text{open}$ $V_+ = 0$, $V_- = 0$	+25°C	-20	0.2	20	nA	
			E	-500		500		
Output Clamp Current, Supplies On	I_{AOUT}	$V_{\text{AIN}} = 25\text{V}$	+25°C	13	19	26	mA	
		$V_{\text{AIN}} = -25\text{V}$	+25°C	-26	-19	-13		
Output Clamp Resistance, Supplies On	R_{AOUT}	$I_{\text{AOUT}} = 1\text{mA}$	$V_{\text{AIN}} = 25\text{V}$	+25°C		0.5	1.0	k Ω
			$V_{\text{AIN}} = -25\text{V}$	+25°C		0.4	1.0	
±Fault Output Turn-On Delay Time		$R_L = 10\text{k}\Omega$, $V_{\text{AIN}} = \pm 25\text{V}$	+25°C		10		ns	

Fault-Protected, High-Voltage, Signal-Line Protector

MAX4505

ELECTRICAL CHARACTERISTICS—Dual Supplies (continued)

(V+ = +15V, V- = -15V, T_A = T_{MIN} to T_{MAX}, unless otherwise noted. Typical values are at T_A = +25°C.) (Note 3)

PARAMETER	SYMBOL	CONDITIONS	T _A	MIN	TYP	MAX	UNITS
±Fault Recovery Time		R _L = 10kΩ, V _{AIN} = ±25V	+25°C		25		μs
POWER SUPPLY							
Power-Supply Range	V+, V-		E	±8		±18	V
Power-Supply Current	I+	V _{AIN} = 15V	+25°C		45	150	μA
			E			240	
	I-	V _{AIN} = 15V	+25°C	-150	-45		
			E	-240			

ELECTRICAL CHARACTERISTICS—Single Supply

(V+ = +12V, V- = 0, T_A = T_{MIN} to T_{MAX}, unless otherwise noted. Typical values are at T_A = +25°C.) (Note 3)

PARAMETER	SYMBOL	CONDITIONS	T _A	MIN	TYP	MAX	UNITS
ANALOG SWITCH							
Fault-Free Analog Signal Range (Note 4)	V _{AIN}	V _{AIN} = 12V	E	0		V+	V
Analog Signal-Path Resistance	R _{ON}	V _{AIN} = 10V, I _{AOUT} = 1mA	+25°C		125	200	Ω
			E			250	
Signal-Path Leakage Current (Note 5)	I _{AOUT(ON)}	V _{AIN} = 10V or floating	+25°C	-0.5	0.05	0.5	nA
			E	-20		20	
FAULT PROTECTION							
Fault-Protected Analog Signal Range (Notes 4, 6)	V _{AIN}	Applies with power on	E	-36		36	V
		Applies with power off	E	-40		40	
Input Signal-Path Leakage Current, Supply On (Note 7)	I _{AIN(ON)}	V _{AIN} = ±25V, V _{AOUT} = 0	+25°C	-20	0.2	20	nA
			E	-200		200	
Input Signal-Path Leakage Current, Supply Off (Note 7)	I _{AIN(OFF)}	V _{AIN} = ±40V	+25°C	-20	0.2	20	nA
			E	-500		500	
Output Clamp Current, Supply On	I _{AOUT}	V _{AIN} = 25V	+25°C	3	5.5	10	mA
Output Clamp Resistance, Supply On	R _{AOUT}	V _{AIN} = ±25V	+25°C		1.0	2.5	kΩ
±Fault Output Turn-On Delay Time		R _L = 10kΩ, V _{AIN} = 25V	+25°C		10		ns
±Fault Recovery Time		R _L = 10kΩ, V _{AIN} = 25V	+25°C		2.5		μs
POWER SUPPLY							
Power-Supply Range	V+, V-		E	+9		+36	V
Power-Supply Current	I+	V _{AIN} = 12V	+25°C		5	25	μA
			E			40	

Note 3: The algebraic convention is used in this data sheet; the most negative value is shown in the minimum column.

Note 4: See Fault-Free Analog Signal Range vs. Supply Voltage graph in the *Typical Operating Characteristics*.

Note 5: Leakage parameters are 100% tested at maximum rated hot temperature and guaranteed by correlation at T_A = +25°C.

Note 6: Guaranteed by design.

Note 7: Guaranteed by testing with dual supplies.

Note 8: SOT packaged parts are 100% tested at +25°C. Limits at the maximum rated temperature are guaranteed by design and correlation limits at +25°C. Leakage tests are typical for SOT packaged parts.

Fault-Protected, High-Voltage, Signal-Line Protector

Typical Operating Characteristics

($T_A = +25^\circ\text{C}$, unless otherwise noted.)

ON-RESISTANCE vs. OUTPUT VOLTAGE (DUAL SUPPLIES)

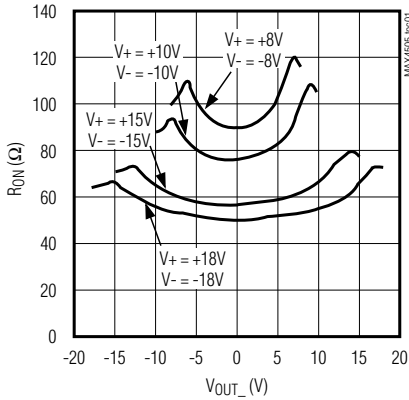

ON-RESISTANCE vs. OUTPUT VOLTAGE (SINGLE SUPPLY)

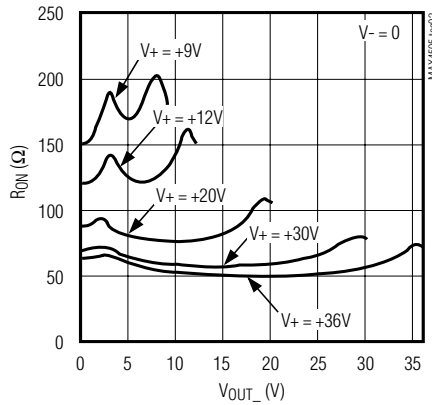

ON-RESISTANCE vs. OUTPUT VOLTAGE AND TEMPERATURE (DUAL SUPPLIES)

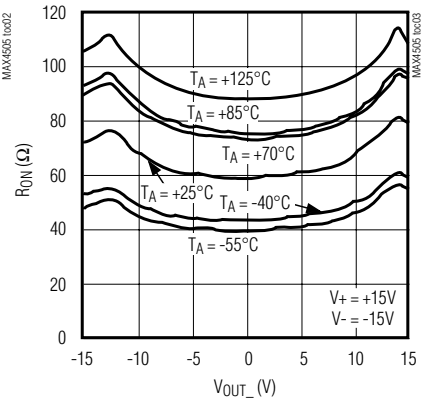

ON-RESISTANCE vs. OUTPUT VOLTAGE AND TEMPERATURE (SINGLE SUPPLY)

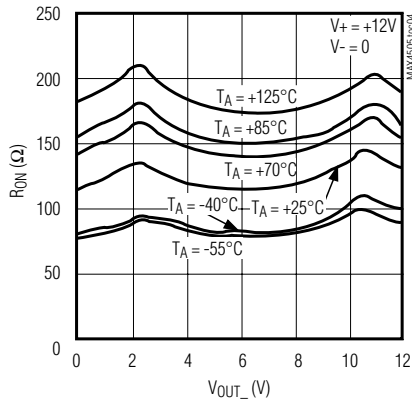

OUTPUT CLAMP RESISTANCE (SUPPLIES ON) vs. TEMPERATURE

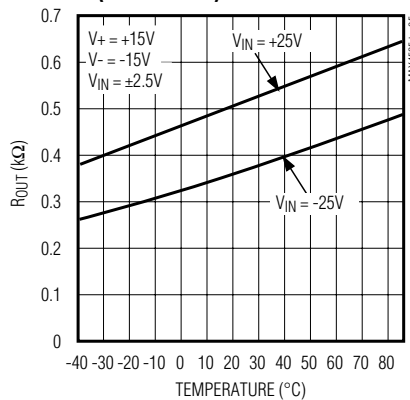

OUTPUT CLAMP CURRENT (SUPPLIES ON) vs. TEMPERATURE

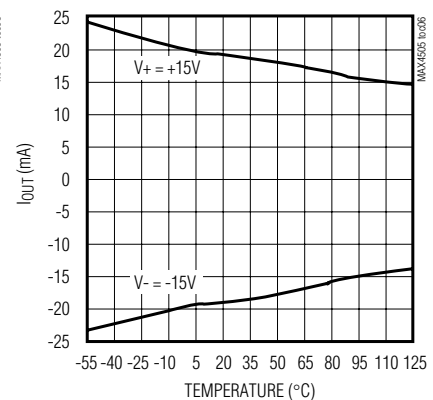

OUTPUT TRANSFER CHARACTERISTICS (DUAL SUPPLIES)

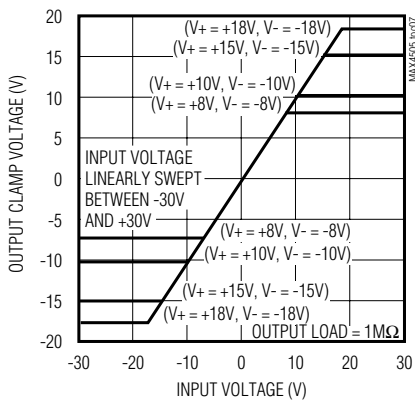

OUTPUT TRANSFER CHARACTERISTICS (SINGLE SUPPLY)

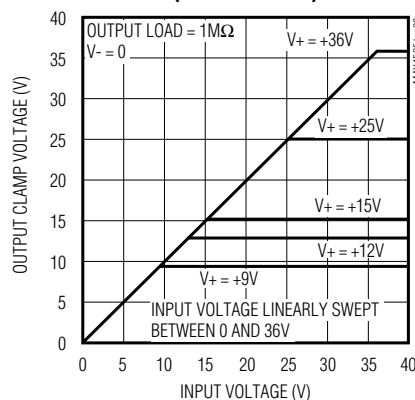

FAULT-FREE ANALOG SIGNAL RANGE vs. SUPPLY VOLTAGE

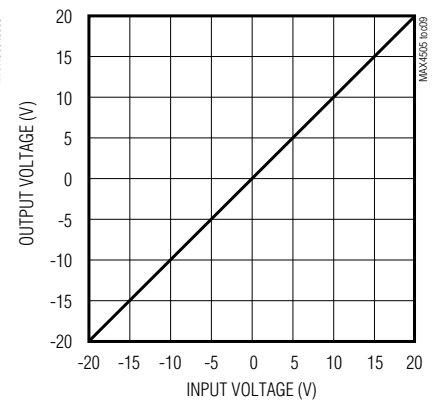

Fault-Protected, High-Voltage, Signal-Line Protector

MAX4505

Typical Operating Characteristics (continued)

($T_A = +25^\circ\text{C}$, unless otherwise noted.)

FAULT-FREE OUTPUT LEAKAGE CURRENT (SUPPLIES ON)

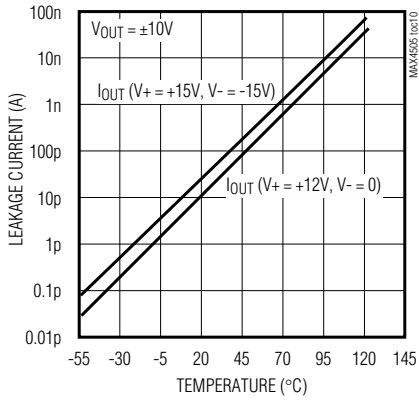

INPUT FAULT LEAKAGE CURRENT (SUPPLIES ON)

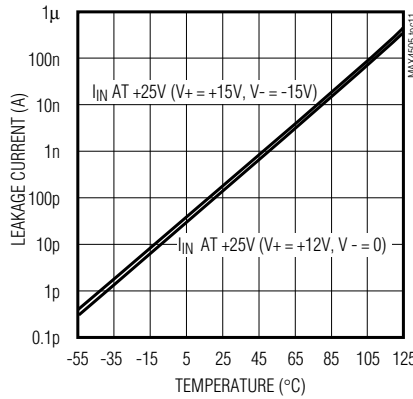

POWER SUPPLY CURRENT vs. TEMPERATURE

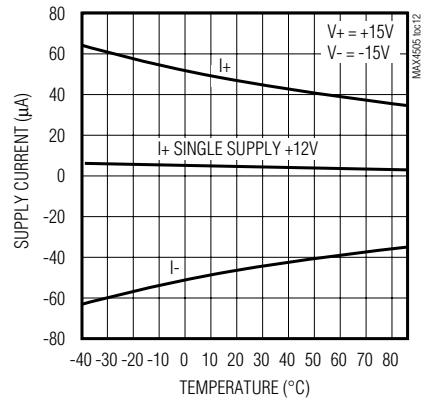

SUPPLY CURRENT vs. INPUT VOLTAGE

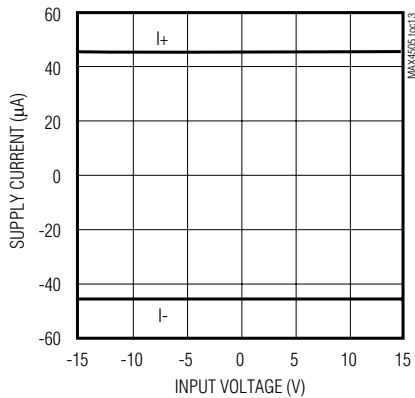

FREQUENCY RESPONSE

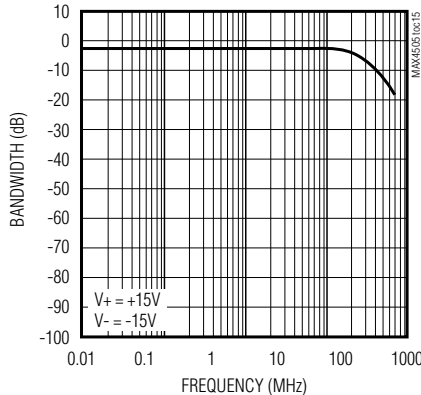

FAULT-FREE SIGNAL PERFORMANCE

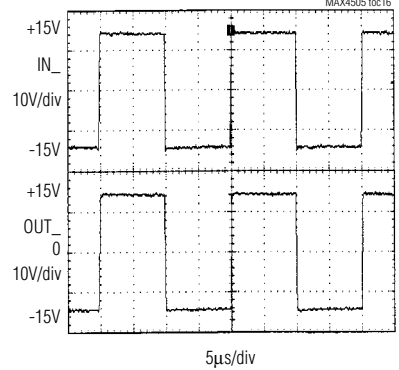

FAULT-FREE RAIL-TO-RAIL SIGNAL HANDLING WITH $\pm 15\text{V}$ SUPPLIES

INPUT OVERVOLTAGE vs. OUTPUT CLAMPING

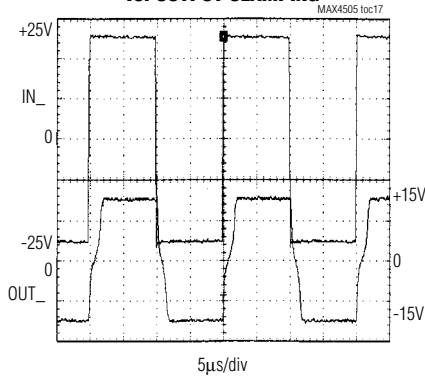

$\pm 25\text{V}$ OVERVOLTAGE INPUT WITH THE OUTPUT CLAMPED AT $\pm 15\text{V}$

FAULT RECOVERY

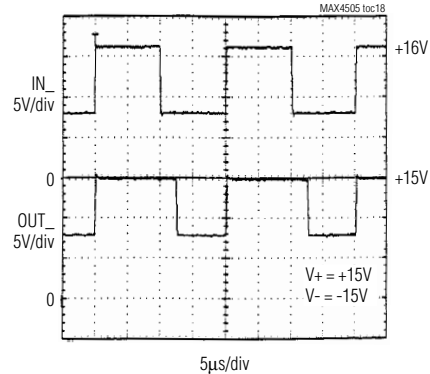

Fault-Protected, High-Voltage, Signal-Line Protector

Pin Description

PIN		NAME	FUNCTION
SOT	μMAX		
1	3	AIN	Analog Fault-Protected Input
2	8	V+	Positive Supply Voltage Input
3	1	AOUT	Analog Signal Output
4	2, 5, 6, 7	N.C.	No Connection. Not internally connected.
5	4	V-	Negative Supply Voltage Input

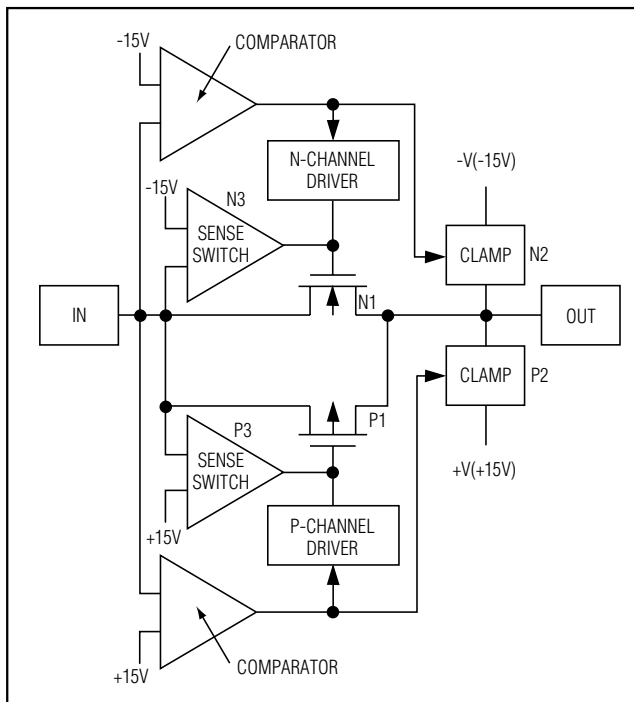

Figure 1. Simplified Internal Structure

Detailed Description

The MAX4505 protects other ICs from overvoltage by clamping its output voltage to the supply rails. If the power supplies to the device are off, the device clamps the output to 0V. The MAX4505 provides protection for input signals up to $\pm 36\text{V}$ with the power supplies on and $\pm 40\text{V}$ with the power supplies off.

The MAX4505 protects other integrated circuits (ICs) connected to its output from latching up. Latchup is caused by parasitic SCR(s) within the IC turning on, and can occur when the supply voltage applied to the IC exceeds the specified operating range. Latchup can

also occur when signal voltage is applied before the power-supply voltage. When in a latchup state, the circuit draws excessive current and may continue to draw excessive current even after the overvoltage condition is removed. A continuous latchup condition may damage the device permanently. Such “faults” are commonly encountered in modular control systems where power supplies to interconnected modules may be interrupted and reestablished at random. Faults can happen during production testing, maintenance, start-up, or a power failure.

Figure 1 shows the normal complementary pair (N1 and P1) found in many common analog switches. In addition to these transistors, the MAX4505 also contains comparators, sensing circuitry, and clamping circuitry to control the state of N1 and P1. During normal operation, N1 and P1 remain on with a typical 65Ω on-resistance between IN and OUT.

The on-board comparators and sensing circuitry monitor the input voltage for possible overvoltage faults. Two clamp circuits limit the output voltage to within the supply voltages. When the power supplies are off, any input voltage applied at IN turns off both N1 and P1, and OUT is clamped to 0V.

Normal Operation

When power is applied, the protector acts as a resistor in series with the signal path. A voltage on the “input” side of the switch conducts through the protector to the output (Figure 2).

When the output load is resistive, it draws current through the protector. The internal resistance is typically less than 100Ω . The MAX4505 does not affect high-impedance loads. The protector’s path resistance is a function of the supply voltage and the signal voltage (see *Typical Operating Characteristics*).

Fault-Protected, High-Voltage, Signal-Line Protector

MAX4505

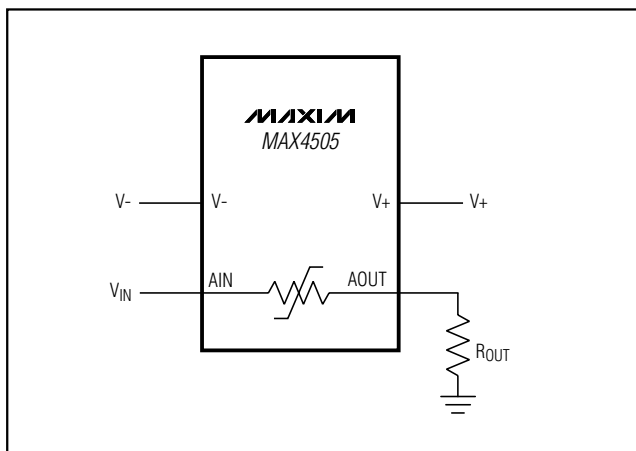

Figure 2. Application Circuit

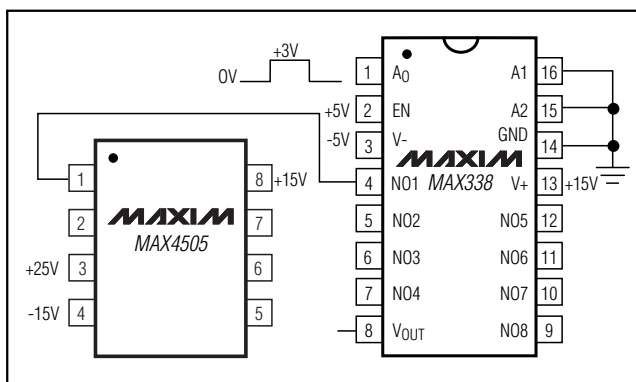

Figure 3. Protecting a MAX338 with a MAX4505

Fault Protection with Power Off

When power is off (i.e., $V_+ = V_- = 0$), the protector is a virtual open circuit. The output stays at 0 with up to $\pm 40V$ applied to the input.

Fault Protection with Power On

A fault condition exists when the voltage on AIN exceeds either supply rail. This definition is valid when power is on or off, as well as during all states while power ramps up or down.

Applications Information

Supplying Power Through External ICs

The MAX4505 has low supply current ($<250\mu A$), which allows the supply pins to be driven by other active circuitry instead of connected directly to the power sources. In this configuration, the part can be used as a driven fault-protected switch with V_+ or V_- used as the

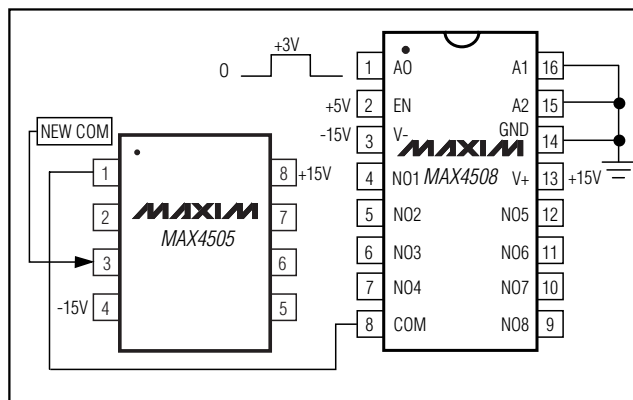

Figure 4. Demultiplexer Application Using MAX4505 with MAX4508

control pins. For example, with the V_- pin grounded, the output of a CMOS gate can drive the V_+ pin to turn the device on and off. Ensure that the driving source(s) does not drive the V_+ pin more negative than the V_- pin.

Protector as Circuit Elements

Figure 3 shows a MAX4505 used in front of a MAX338 unprotected 1-to-8 multiplexer. With supplies at $\pm 15V$, V_{AOUT} of the MAX4505 clamps to $\pm 15V$ and V_{OUT} of the MAX338 goes to $\pm 14V$. With supplies off, V_{AOUT} goes to 0 even though the input remains at $\pm 25V$.

Multiplexer and Demultiplexer

The MAX4505 can be used in series with the output of a MAX4508 (1-to-8 multiplexer) to act as multiplexer or demultiplexer. The MAX4508 is a fault-protected multiplexer whose inputs are designed to interface with harsh environments; however, its common output is not fault protected if connected to outside signals (i.e., demultiplexer use). If the common output can see fault signals, then it needs to be protected, and the MAX4505 can be added to provide complete protection.

As seen in Figure 4, the signal input can now be put into pin 3 of the MAX4505 (new common output for system), and outputs can be taken at MAX4508 pins 4 to 7, and 9 to 12. This is the classic demultiplexer operation. This system now has full protection on both of the multiplexers' inputs and outputs.

Measuring Path Resistance

Measuring path resistance requires special techniques, since path resistance varies dramatically with the AIN and AOUT voltages relative to the supply voltages. Do not use conventional ohmmeters. Their applied voltage and currents are usually unpredictable. The true resis-

Fault-Protected, High-Voltage, Signal-Line Protector

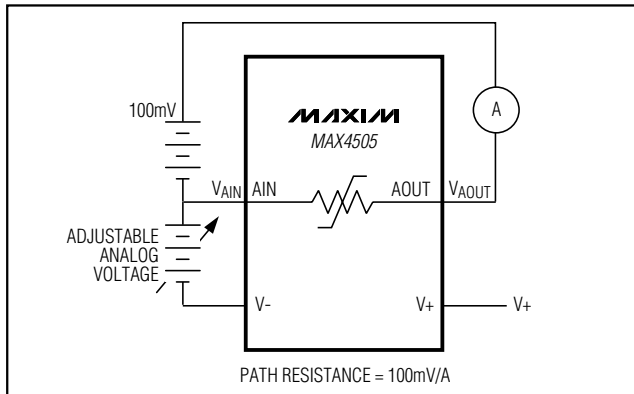

Figure 5. Path-Resistance Measuring Circuit

tance is a function of the applied voltage, which is dramatically altered by the ohmmeter itself. Autoranging ohmmeters are particularly unreliable.

Figure 5 shows a circuit that gives reliable results. This circuit uses a 100mV voltage source and a low-voltage-drop ammeter as the measuring circuit, and an adjustable supply to sweep the analog voltage across its entire range. The ammeter must have a voltage drop of less than 1mV (up to the maximum test current) for accurate results. A Keithley model 617 electrometer has a suitable ammeter circuit, appropriate ranges, and a built-in voltage source designed for this type of measurement. Find the path resistance by setting the analog voltage, measuring the current, and calculating the path resistance. Repeat the procedure at each analog and supply voltage.

Note that it is important to use a voltage source of 100mV or less. As shown in Figure 5, this voltage and the V_{AIN} voltage form the V_{AOUT} voltage. Using higher voltages could cause AOUT to go into a fault condition prematurely.

Pin Configurations (continued)

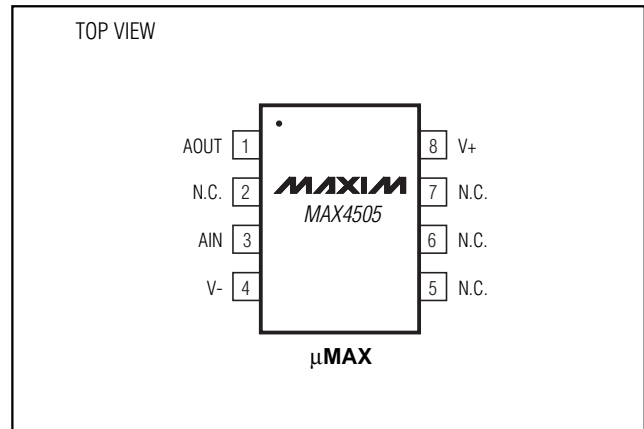

Chip Information

TRANSISTOR COUNT: 56

Maxim cannot assume responsibility for use of any circuitry other than circuitry entirely embodied in a Maxim product. No circuit patent licenses are implied. Maxim reserves the right to change the circuitry and specifications without notice at any time.

8 **Maxim Integrated Products, 120 San Gabriel Drive, Sunnyvale, CA 94086 408-737-7600**